



# User's Guide

**WARNING:** Shallow water! Never jump or dive into a Splash SuperPool; serious bodily injury could occur.

If you have any questions on the assembly of your Splash SuperPool or Splash OmegaPool, please call your local Splash SuperPools dealer.



Splash SuperPools, LLC • 3912 East Progress • North Little Rock, AR USA 72114  
(800) 92-SPLASH • <http://www.splashpools.com>

©2003-Splash Superpools Ltd.

# *Congratulations on the purchase of your Splash SuperPool!*

*A few notes prior to assembly. . .*

*Be sure that you have an area that is smooth, level and 4 feet larger than the pool to assemble your SuperPool. Remove all sticks, rocks, and any sharp objects. Remove and cap off any sprinkler heads, fill voids, depressions, or hollows with dirt or sand. Any areas filled with dirt or sand must be compacted prior to installation of your pool.*

*If you are installing your SuperPool on dirt, sand, or grass, we recommend that you place a plastic sheet or foam pad between your pool and the ground.*

*Splash SuperPools are portable swimming pools, and as a result, most localities do not require the homeowner to obtain any permits. However, it is the homeowner's responsibility to meet all applicable safety/health codes and zoning regulations.*

**WARNING: NEVER INSTALL YOUR SUPERPOOL UNDERNEATH HIGH VOLTAGE POWER LINES — SERIOUS INJURY OR DEATH COULD RESULT.**

**WARNING: SHALLOW WATER! NEVER JUMP OR DIVE INTO A SPLASH SUPERPOOL — SERIOUS BODILY INJURY COULD OCCUR!**

# Table of Contents

Congratulations! .....	3
SuperPool Parts List.....	5
Getting Started .....	6
Installing Circulation System .....	10
Adding Optional Skimmer.....	12
Filling and Starting Your Pool .....	13
Omega Parts List.....	14
Omega Assembly Instructions .....	15
Vacuuming Your Splash SuperPool .....	20
Cleaning Filter and Pump Basket.....	19
Winterizing Your Splash SuperPool.....	21
Ladder Assembly .....	22
SplashLadder .....	23
Omega Ladder .....	29

***Never leave children or inexperienced swimmers alone in any pool.***

# Splash SuperPools Parts List

- |                              |                                  |
|------------------------------|----------------------------------|
| A. Male Top Rail End Piece   | I. Hose w/Threaded Nipple/Gasket |
| B. Middle Top Rail Section   | J. Floating Skimmer Weir         |
| C. Female Top Rail End Piece | K. Skimmer Hold Down Fitting     |
| D. Leg                       | L. Skimmer Basket                |
| E. SplashBlox                | M. Skimmer                       |
| F. Stainless Steel Ring      | N. Vacuum Adapter Plate          |
| G. Connecting Pin            | O. Ball Valve                    |
| H. Wall Fittings             | P. Eyeball Fitting               |

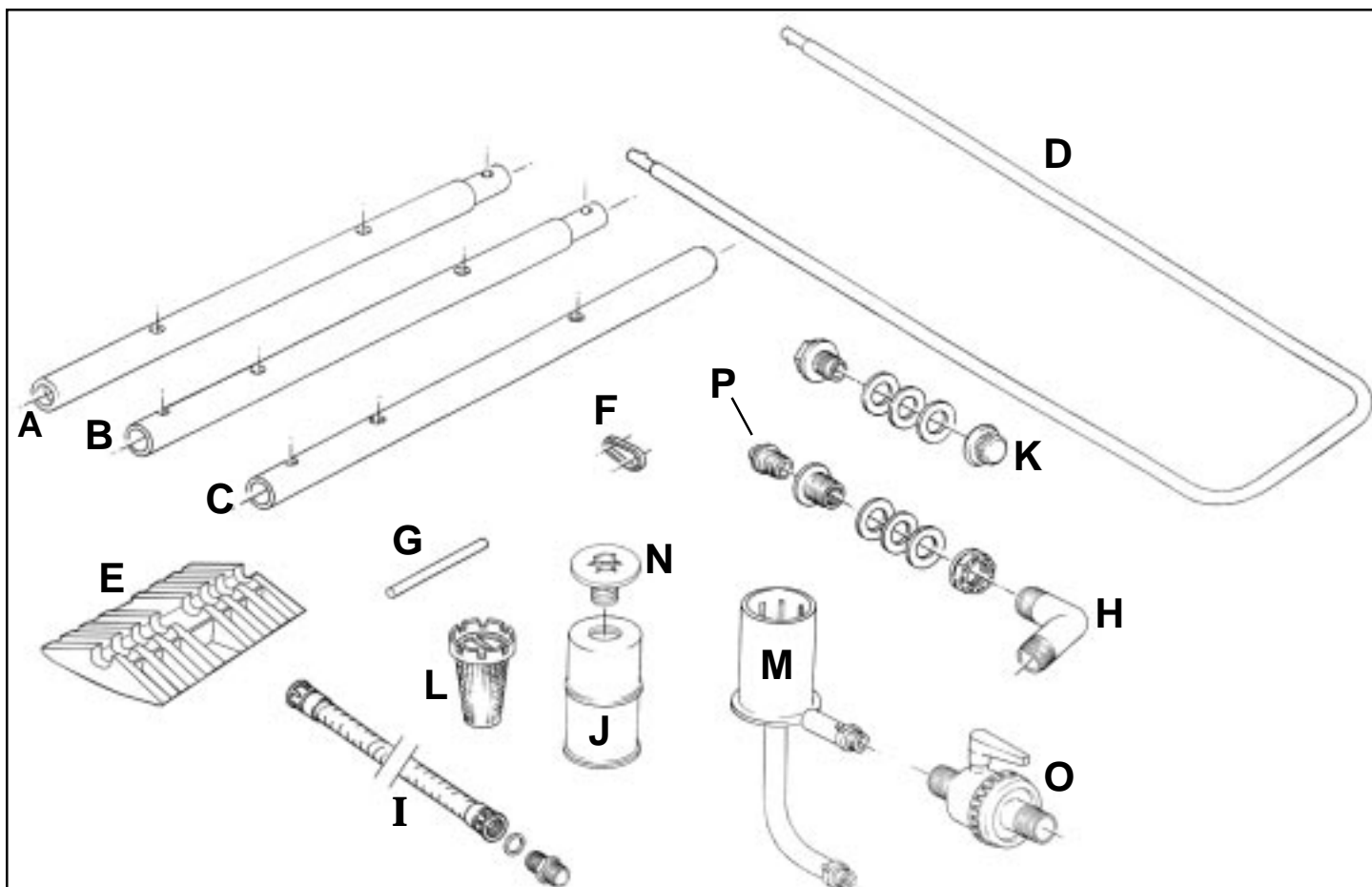

# Getting Started

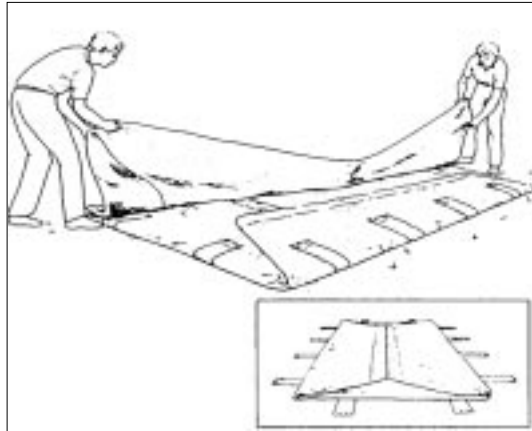

1. Unfold your pool on your selected and prepared site. Locate the pre-punched plumbing holes in one of the short walls of the pool and position them where you want your pump and filter to be located. **CAUTION:** Electrical outlet will require GFI (ground fault interruption) protection. Hint: Your SuperPool skimmer can be even more effective if located at the prevailing “down wind” end of the pool. **WARNING:** Make sure you do not install your pool under electrical lines.

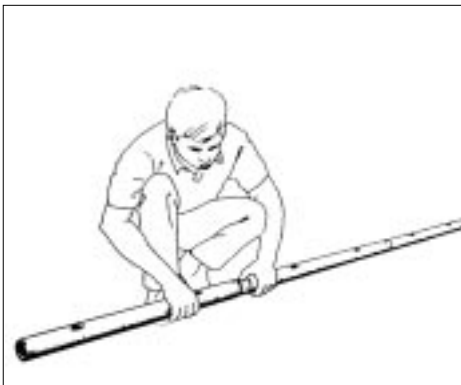

2. Insert the galvanized steel Top Rails into the seamed pockets at the top edge of the pool. There is a slot located in each corner that will accept the Top Rails. Insert one Female End Piece (C) into the sleeve; continue adding Middle Top Rail Sections (B) as you slide the rail into place, until the necessary length is obtained. Finish each wall with a Male End Piece (A). Once all top rails are inserted, align pre-punched holes in pool with holes in Top Rail.

Hints: Set rails out around the perimeter of the pool before you begin assembly.

Insert rails into the long sides of the pool first. As you insert each piece of the rail and begin to slide, it helps to pull and tighten the white sleeve to avoid hitting wrinkles. Be careful not to scrape the ends of the railing along the pool material.

On hot days the rails may “grab” the sleeve as you are inserting them. This can be prevented by wetting the top rails with a garden hose as you insert them.

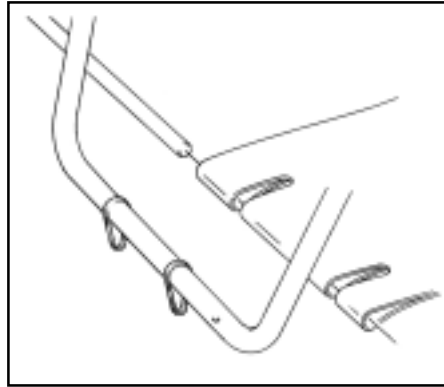

3. Above is an illustration of the assembly of the Splash SuperPool Legs. Slide the two Stainless Steel Rings onto the Leg. Continue this process until you have assembled all the Buttress Legs.

**Item 2A**



**Item 2B**

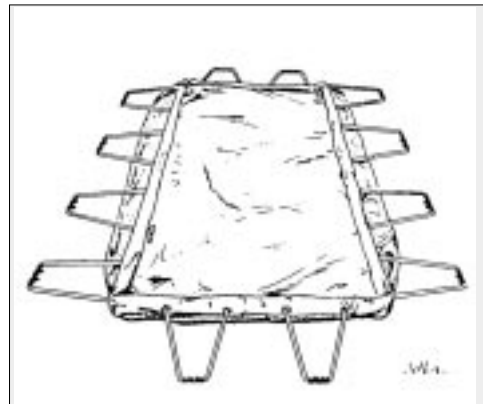

4. Insert the Leg into the Top Rail as in Item 2A, spreading the Leg apart until it slides into the holes. When all the buttresses are inserted, the pool will look like Item 2B. Finally, connect Leg with Connecting Pin to the pool buttress strap as in Item 3.

**Item 3**

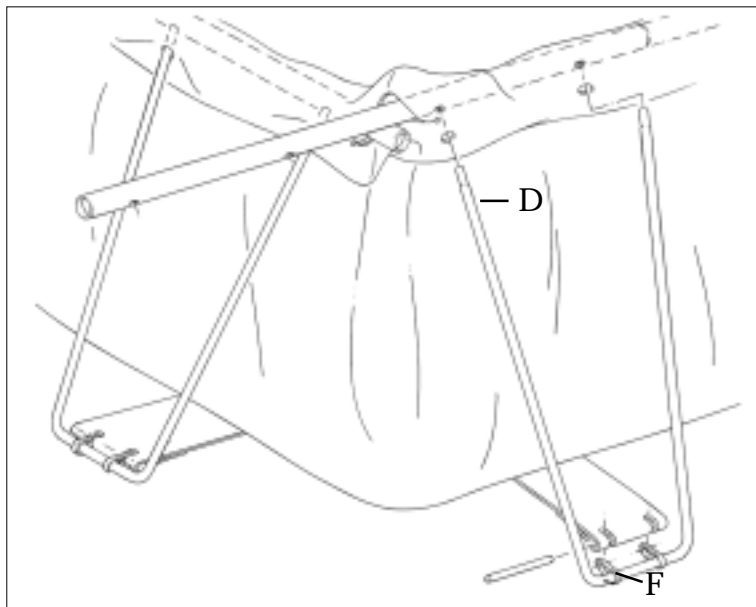

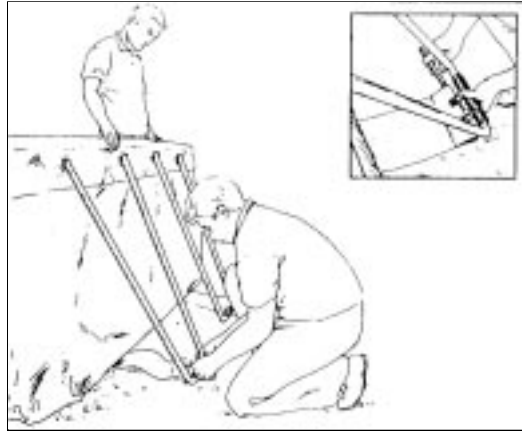

- Put one person inside the pool to hold the wall at the Top Rail. Insert the Connecting Pins (G), to connect the pool straps to the Stainless Steel Rings. Repeat this process with all four walls.

Note: At this stage, all four walls will be leaning inward; this is normal. They will automatically move to their proper positions once the pool is filled with water.

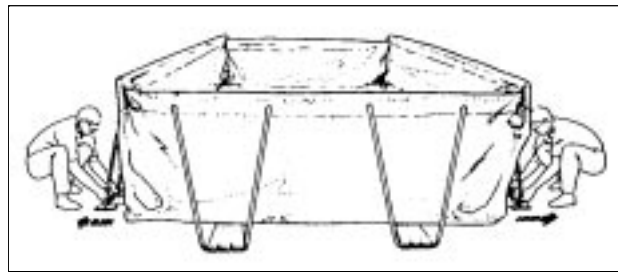

- Gently pull buttress straps away from the center of the pool to insure a wrinkle-free installation.

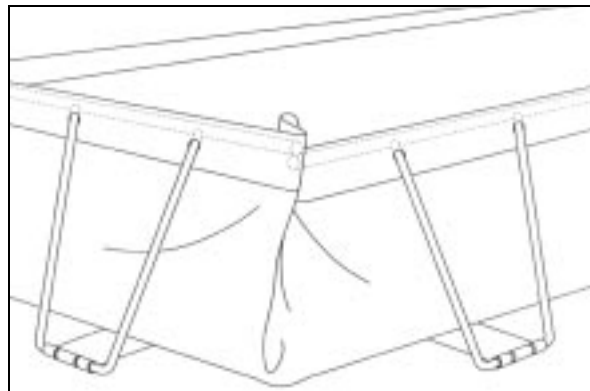

- Position the short wall Top Rails so they are leaning over and on top of the long wall Top Rails.

***WARNING: Shallow water! Never jump or dive into a Splash SuperPool; serious bodily injury could occur.***

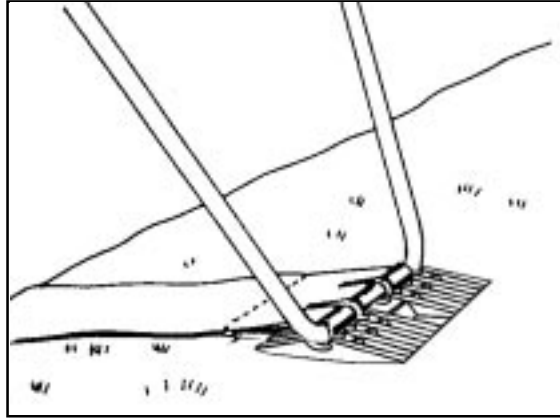

8. There must be solid support under each Buttress Leg because, when the pool is filled, the weight on each Leg will be approximately 2,000 pounds. If the pool is on a surface other than concrete, the recommended method of support is to utilize the included SplashBlox (grey footblock). Place the SplashBlox under the Leg, placing the Leg into the recess on the top of the SplashBlox. The SplashBlox is designed to provide the proper support to the Leg to move as the pool fills.

Note: The Buttress Leg must be placed in the center of the support.

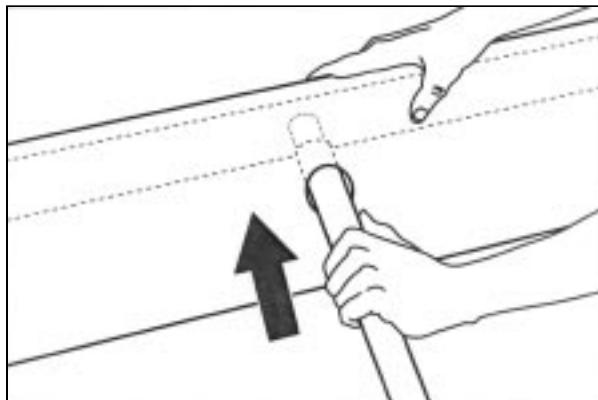

9. In the positioning of your Splash SuperPool, make sure that all Buttress Leg tubes are still inserted properly into the Top Rail. Do this by placing your hand on the Top Rail where the individual Leg tubes insert, and feel with thumb and fingers. If you find that a Leg has been dislodged, re-insert it into the Top Rail.

***WARNING: Shallow water! Never jump or dive into a Splash SuperPool; serious bodily injury could occur.***

# Installing the Circulation System

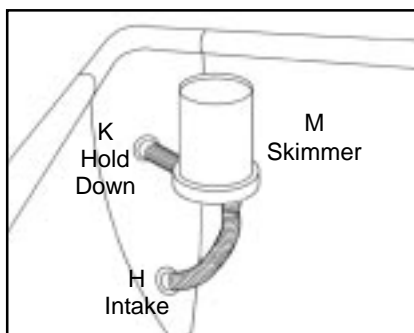
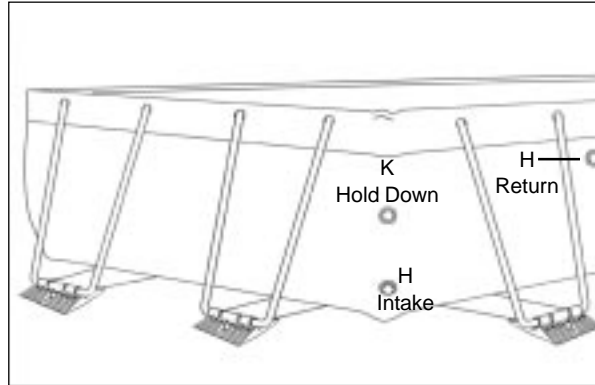

See (L) on page 2 for Skimmer Hold Down assembly diagram.

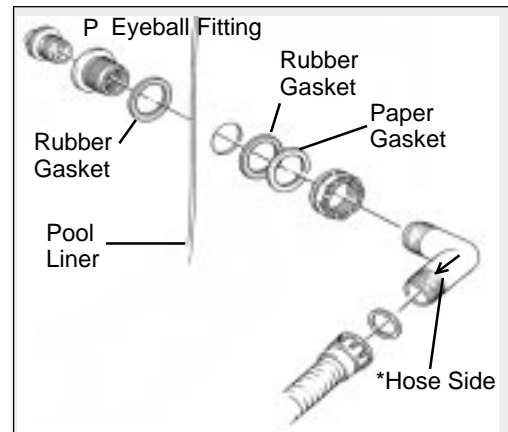

1. Wall Fitting Installation — Install the two Wall Fittings (H) at the locations labeled “intake” and “return”. Also install the Skimmer Hold Down Fitting (K) in its marked location. Each of these three fittings has two rubber and one paper gasket. These should be positioned as in the diagram above. No thread sealer or Teflon tape is required.
2. Skimmer Installation — From inside the pool, screw hose from bottom of Skimmer (M) into the Intake Wall Fitting, and hand-tighten. No Teflon tape is required. Note: use soapy water to slide hose onto bottom of skimmer. Next, screw the short hose from the side of the Skimmer into the Skimmer Hold Down Fitting (K). Again, hand-tighten. Screw the Eyeball Fitting (P) into the Return Wall Fitting. \*Note that “hose side” is imprinted on the 90 Degree Fitting for your convenience. Now is when the person inside the pool will want to get out.
3. Pump and Filter Installation — Please refer to the directions supplied by the manufacturer of your pump and filter.

NOTE: The 17' x 29.5' SuperPool has holes for an optional extra skimmer. If you choose not to use an extra skimmer, use the supplied Wall Fittings and plugs to seal holes.

***WARNING: The circulation system produces very strong suction. NEVER lay on or insert body parts into the skimmer. Always turn off pump before working on the skimmer.***

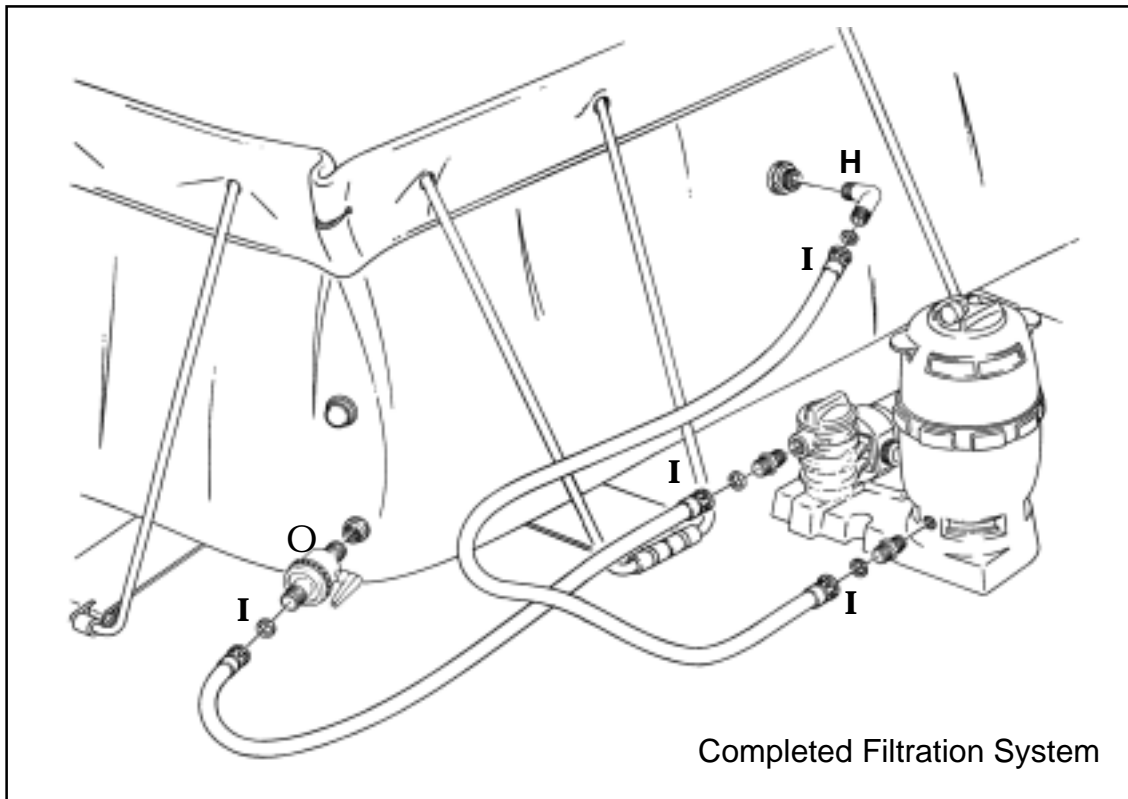

4. Tighten Fittings – Make sure all fittings connecting the pump and filter are tight.
5. Tape – Wrap Teflon tape on the threads of the Ball Valve (O) going into the Wall Fitting (H) and screw tightly into the Intake Wall Fitting.
6. Attach Hoses – (Be sure to use only Teflon tape on all Threaded Fittings. Do not use the Teflon tape, however, on the hose side of the Threaded Fittings. DO NOT USE PIPE SEALANT.) Take one of the hoses and attach one end (H) to the Ball Valve (O) using a Gasket. Take the other end (I) and attach it to the suction side of the pump and filter with a Threaded Nipple and a Gasket. Note that “hose side” is imprinted on the Threaded Nipple for your convenience. Once sealed, hose will not spin. Next, attach one end (I) of the second hose to the Return Wall Fitting (H) with a Gasket. Twist the threaded elbow into the Wall Fitting before attaching the hose. Then take the other end (I) and attach it with a Threaded Nipple and a Gasket to the Filter Canister. It is helpful to twist the Threaded Nipple into the Filter Canister before the hose. DO NOT USE PIPE SEALANT. Make sure all connections are tight.
7. Warning Label – Affix the Warning Label on the pool liner at the Top Rail next to the Floating Skimmer. If the Floating Weir and the internal basket of the Skimmer are removed, the resultant strong suction can trap hair or other body parts if they are inserted into the skimmer. Due to this potential hazard, we are recommending that you affix the Warning Label.

***WARNING: NEVER work on pump, filter, or skimmer while pump is operating or serious injury could occur due to strong suction.***



# Filling and Starting Your Pool

1. Begin adding water to the pool. When the pool has approximately 1" of water on the bottom, shut the water off. Gently pull on the foot straps to remove any remaining wrinkles. The sides will rise automatically and will be in their proper position when the pool is full. Full position is when water level is approximately 3" from the top of the pool.
2. When the pool is full, plug in the circulation system, making certain the Ball Valve is open (Handle is inline with hose). You will begin to see water being pulled down into the skimmer. The pump basket area will also fill with water, as seen through the clear lid. At the same time, the pressure gauge on top of the filter will show that water is filling the tank.
3. At this time, "bleed" air from the circulation system by loosening the small threaded plug on the filter lid. You will hear air escaping. Once all the air has escaped, water will follow. When this happens, retighten the plug. The circulation system has now been primed.
4. Assemble the ladder, per instructions, and place it where desired in the pool. (Refer to page 19 for Ladder Assembly Instructions.)
5. Start enjoying your pool.

***WARNING: SHALLOW WATER!  
NEVER JUMP OR DIVE INTO A SPLASH  
SUPERPOOL!***

***WARNING: NEVER work on pump, filter or skimmer  
while pump is operating or serious injury could  
occur due to strong suction.***

# OmegaPool Parts List

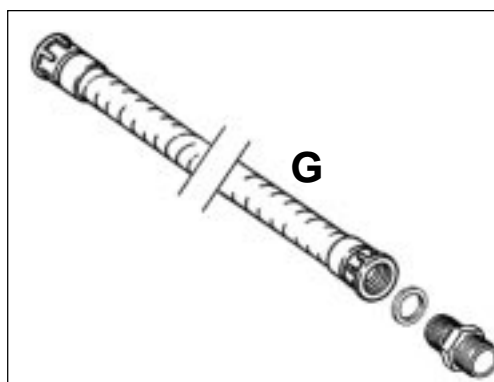
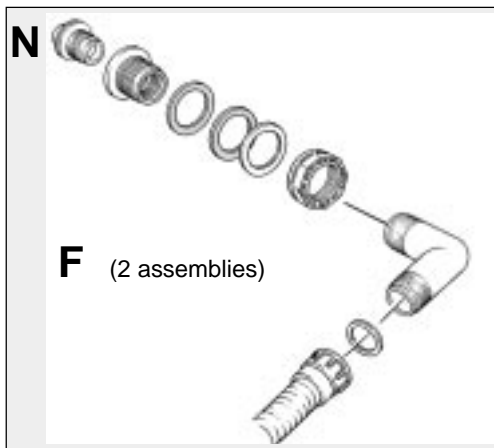
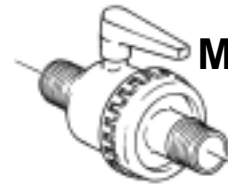
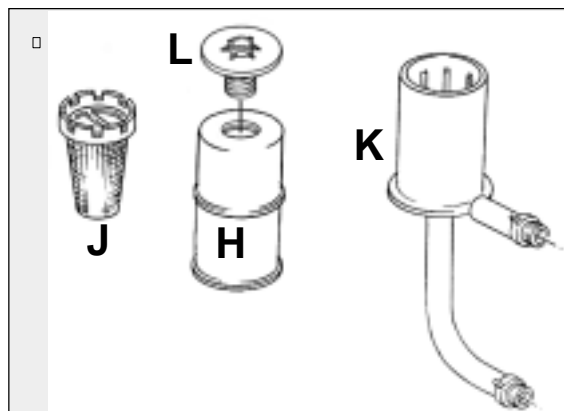
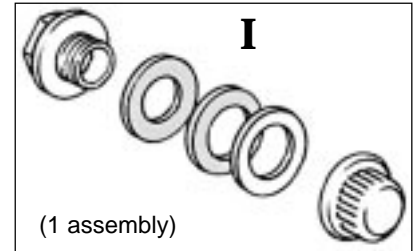
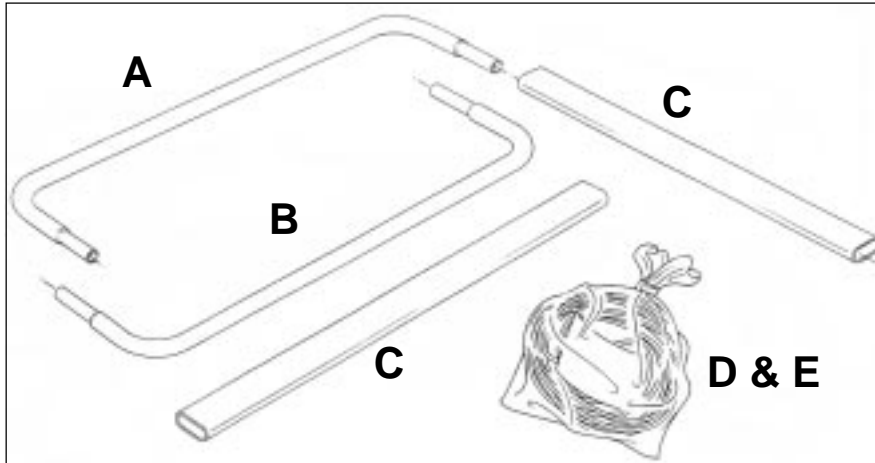

- A. Galvanized Top Structure Tube
- B. White Powder Coated Bottom Structure Tube
- C. Upright Structure Tube
- D. Clear Elastic PVC Hose
- E. Connecting Pins
- F. Wall Fittings
- G. Hose w/Threaded Nipple/Gasket
- H. Floating Skimmer Weir
- I. Skimmer Hold Down
- J. Skimmer Basket
- K. Skimmer
- L. Vacuum Adapter Plate
- M. Ball Valve
- N. Eyeball Fitting

# OmegaPool Assembly Instructions

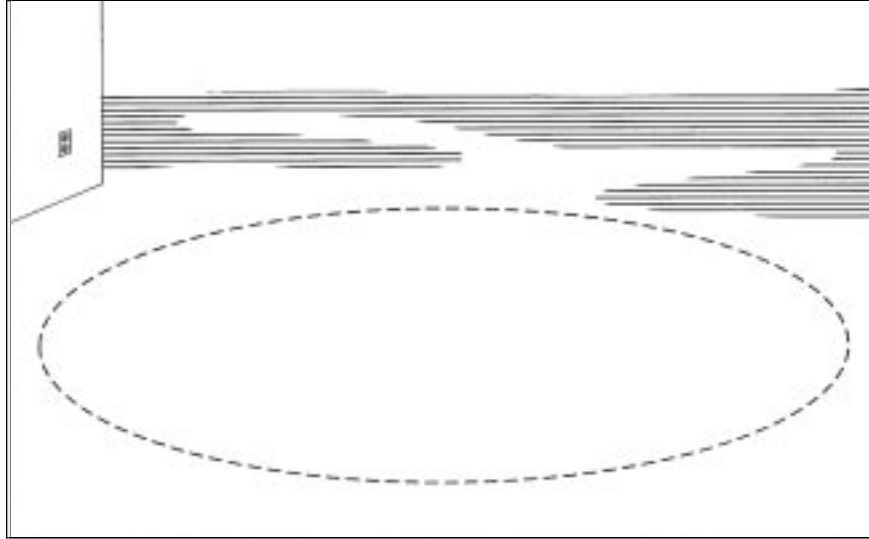

1. Prepare the ground by picking up all sticks, rocks, and other sharp objects that may damage the pool. Add two feet to the pool's size when clearing an area (Clear an 18 foot area for a 16 foot pool.) Make sure the area is level.

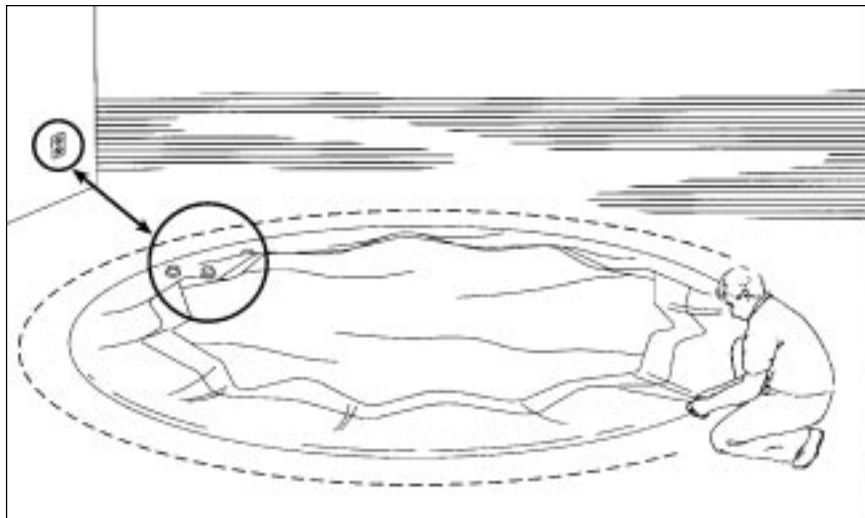

2. Spread the pool out over the cleared surface. Line up holes in the pool (where Skimmer attaches) with the electrical outlet that is planned for the pump and filter.

***WARNING: Shallow water! Never jump or dive into a Splash SuperPool; serious bodily injury could occur.***

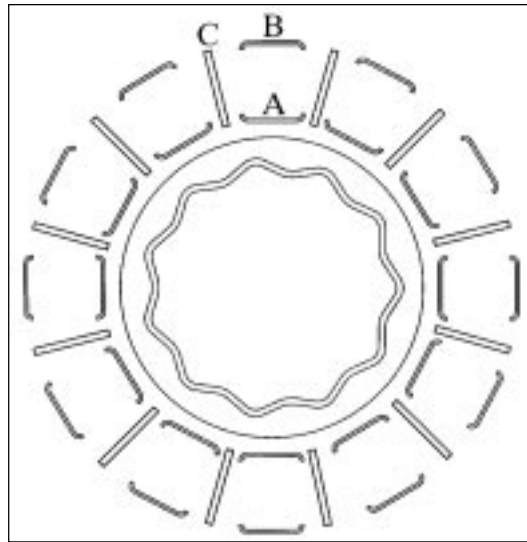

3. Place the structure around the outside of the pool, making sure the top and bottom Structure Tubes lay together. The Galvanized Tubes are the top (A) and the White Tubes are the bottom (B). When laying out the structure, place one Upright Structure Tube (C) with every set of top and bottom Structure Tubes (A & B) .

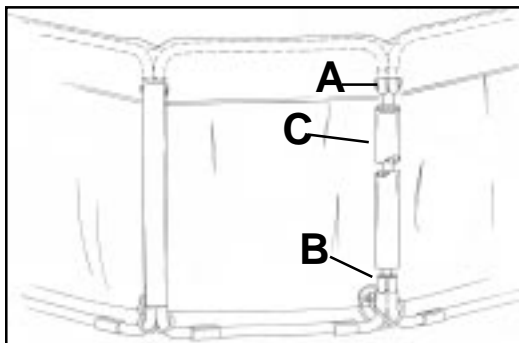

4A

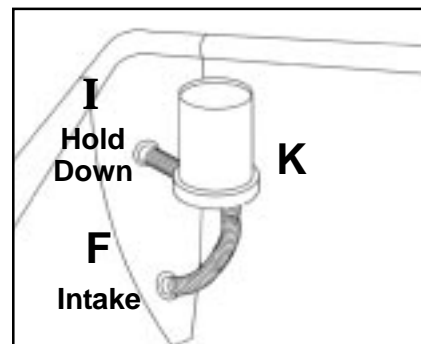

4B

4. Slide the top tube (A) through the openings in the white part of the pool. Insert top tube (A) into Upright Structure Tube (C). Insert bottom Structure Tube (B) into Upright Structure Tube (C), as shown in figure 4A. For ease in assembly, have one person stand inside the pool and one person outside the pool. Continue assembly around the entire pool. Before exiting the pool, attach the Skimmer (K) as shown in figure 4B.

***WARNING: Strong suction! Never lay on or insert body parts into skimmer while pump is operating.***

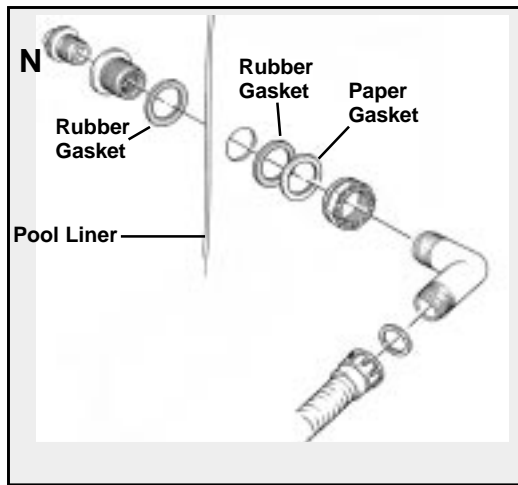

5A

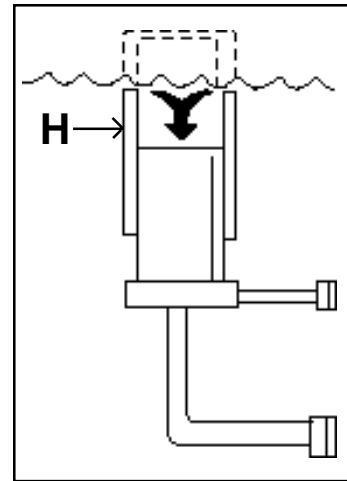

5B

5. Attach the Wall Fittings on the pool (See Figure 5A). Put one Rubber Gasket on the inside of the pool and a Rubber Gasket and Paper Gasket on the outside. Attach the bottom fitting (on the hose at the bottom of the skimmer) to the bottom Wall Fitting. Attach the top hose on the Skimmer to the support fitting. Insert the return Wall Fitting into the pool and screw the return Eyeball Fitting (N) into it. Slide the Floating Skimmer Weir (H) onto the top of the Skimmer (See Figure 5B).

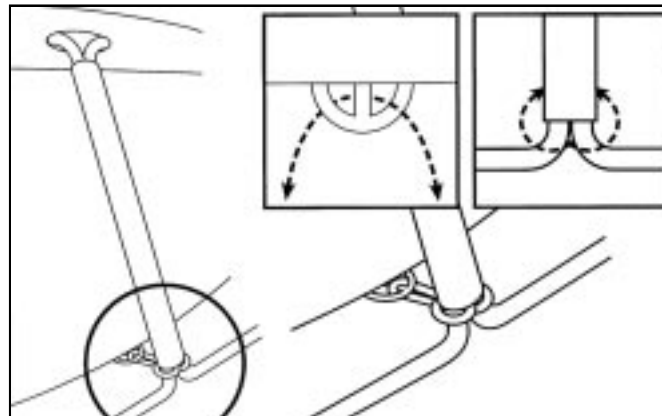

6

6. Place one Clear Elastic PVC Hose (D) by each upright Tube (C). Insert Connecting Pin (E) in one end of the Hose. Thread the Hose through the base attachment on the outside at the bottom of the pool. (See Figure 6) Thread the Hose between the base Tubes and back around both sides of the Tubes. Connect together with Connecting Pin, making sure the Hose is on the inside of the Tubes closest to the pool. Check to insure all wrinkles are removed. (It may be necessary to pull the Elastic Hose to take out a wrinkle.) After pool has been filled with water, remove the Elastic Hose and save for future use.

***WARNING: Strong suction! Never lay on or insert body parts into skimmer while pump is operating.***

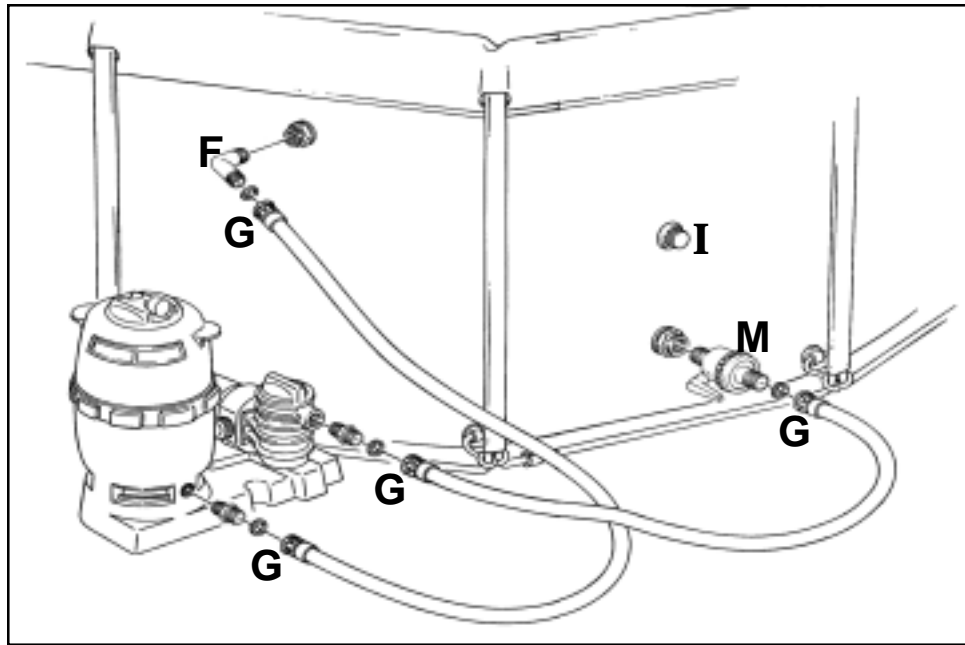

7

7. Connect the pump and filter (as shown in Figure 7) and fill pool with water.

***WARNING: Strong suction! Never lay on or insert body parts into skimmer while pump is operating.***

# Vacuuming Your Splash SuperPool

To vacuum your pool, you may either use an automatic cleaner or the traditional manual method. If you choose the manual method, you will need a 1.5" flexible vacuum hose of adequate length, a vinyl liner vacuum head, and a telescopic pole.

Begin by turning pump and filter off, then place vacuum hose on vacuum head or automatic cleaner. Place vacuum (either auto cleaner or vinyl vacuum head attached to end of telescopic pole) in pool, allowing hose to fill with water. Continue to "feed" hose straight down into water, thus removing air from the hose and replacing it with water. Once you get to the end of the hose, water will come out. Turn pump and filter on and begin vacuuming.

## Automatic Vacuuming

With the pump turned off, place the Vacuum Adapter Plate ("N" on SuperPools, "L" on OmegaPools) on top of the Floating Skimmer Weir ("J" on SuperPools, "H" on OmegaPools). Once the pump is turned on, the suction of the pump will hold the plate in place.

Attach vacuum hose into adapter plate hole. Again, pump suction will hold hose in place. Turn on the pump and filter; the pool is now ready to be vacuumed. The automatic vacuum will run on its own. When pool is clean, turn off pump and filter, unplug vacuum hose, remove vacuum, and remove adapter plate. This is a good time to empty any debris from the Skimmer Basket ("L" on SuperPools, "J" on OmegaPools). Finally, turn pump back on to continue filtering.

***WARNING: Do not attempt to remove or install the vacuum plate while pump and filter are running. The suction is very powerful; fingers may get pinched between the vacuum plate and the skimmer.***

***DO NOT swim in the pool while vacuum is running.***

***WARNING: Keep body parts away from vacuum plate when in place and pump and filter are running.***

# Cleaning Filter and Pump Basket

Over time (from a few days to a few weeks, depending on how much the pool is used and environmental conditions), your filter will require cleaning. You might notice a loss of suction when vacuuming or an increase in filter gauge pressure. You should clean the filter when the pressure increases 8-10 lbs. above the filter's initial start-up pressure.

## A. Sand Filter

1. Begin by shutting off power to the system.
2. Move the lever at top of filter from "filter mode" to "backwash mode".
3. Turn power to the system back on.
4. Continue to backwash until wastewater becomes clear. Note: It is a good idea to attach a hose to the backwash outlet of the filter. Run the hose to an area where the water will drain away. Also, be sure the water level remains high enough so as not to lose the prime.
5. When waste water is clear, shut off power to the system.
6. Turn lever back to the "filter mode" setting.
7. Turn pump and filter back on.

## B. Cartridge Filter

1. Begin by shutting off power to the system.
2. Close the Ball Valve.
3. Screw a Threaded Plug (found in separate plastic bag) into Return Wall Fitting from the inside of the pool.
4. Open Air Relief Valve.
5. Remove the lid from the Filter Canister.
6. Lift out the Cartridge Filter and clean with a garden hose.
7. Clean Filter Canister by removing Drain Plug at base of filter. Replace plug.
8. Replace Filter Element and reattach lid.

## C. Pump Basket

1. Remove pump lid and clean pump basket. Replace lid.
2. Open Ball Valve, remove Threaded Plug from Return Wall Fitting, and close Air Relief Valve.
3. Turn power to the system back on.

***WARNING: Pump must be shut off  
when cleaning***

# Winterizing your Splash Pool

To help guide you in the winterizing process of your Splash Pool, instructions are as follows:

1. The use of winterization chemicals will greatly improve the condition of your water when opening the pool in the spring. These chemicals should be available through your Splash dealer.
2. Disconnect the Skimmer and remove it and all hoses from inside the pool. The Skimmer Wall Fitting will need to be plugged from inside the pool, and the Slice/Ball Valve should be opened to allow it to drain. (The valve can be removed, but must be free of water for the winter.)
3. Drain the water below the Return Fitting, remove the Directional Fitting and do not plug the Wall Fitting. This will help to maintain the low water throughout the winter.
4. All Hoses which connect the pump and filter to the pool should be removed at this time. Properly store the Pump, Filter and Hoses for use next season.
5. Place pillows in the pool and secure to sides, then apply winter Cover (available as an accessory). Splash Covers are made especially for our pools and come complete with bungee cords for fastening.
6. Damage to the pool from ice is not covered by the warranty. Some areas may dictate additional precautions.

Note: If your area does not experience freezing temperatures, disregard items 2-6.

## Accessories

Visit the Splash web site ([www.splashpools.com](http://www.splashpools.com)) for a complete line of accessories available for the Splash family of pools.

***CAUTION: Failure to lower water level could result in ice damage to your pool.***

# SplashLadder Assembly Instructions



# SplashLadder Parts List

- |                                    |                               |
|------------------------------------|-------------------------------|
| A. (2) Interior Step Rails         | J. (2) Step Stiffeners        |
| B. (3) Exterior Steps (Tabs)       | K. (1) Plastic Strap (Spline) |
| C. (2) Interior Steps              | L. (10) Metal Pins            |
| D. (3) Platform Pieces             | M. (10) Plastic Plugs         |
| E. (3) Platform Step Supports      | N. (6) Metal Screws           |
| F. (2) Top Ladder Handles          | O. (2) Long Metal Screws      |
| G. (2) Vertical Supports (White)   | P. (2) Metal "J" Hooks        |
| H. (2) Exterior Step Rails (White) | Q. (1) Ladder Tool            |
| I. (1) Metal Berth Pipe            | R. (1) Warning Label          |

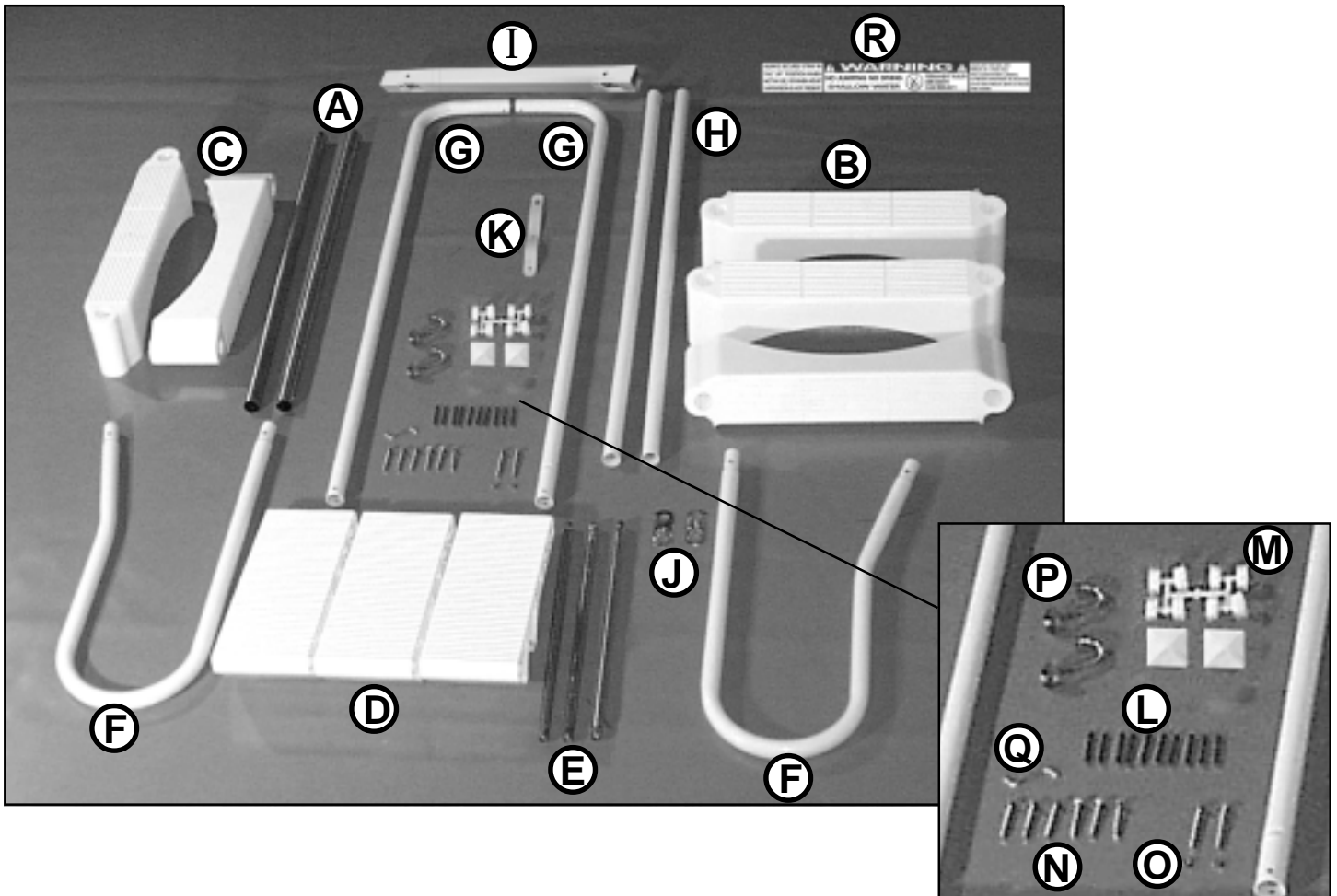

# Step 1: Assembling the Ladder Top

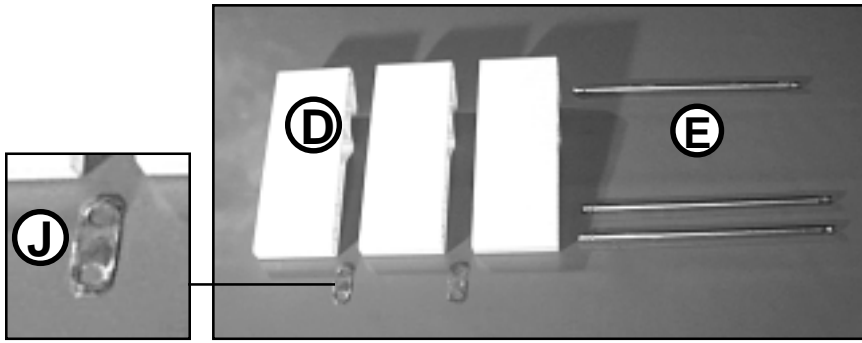

## Parts Needed:

- D. (3) Platform Pieces
- E. (3) Platform Step Supports
- J. (2) Step Stiffeners

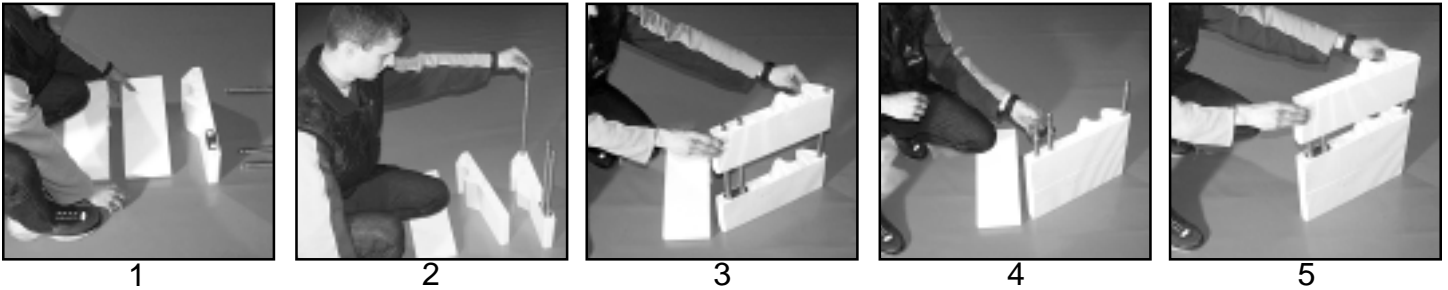

1. Apply the Step Stiffener on the narrow end of one of the Platform Step Supports. 2. Insert the three Platform Step Supports into the Ladder Platform piece with the Step Stiffener. 3. Insert the second Ladder Platform Piece on top of the first and push down. 4. Place the second Step Stiffener on the Second Platform Piece. 5. Insert the final Platform Piece and push down.

# Step 2: Assembling the Waterside Steps

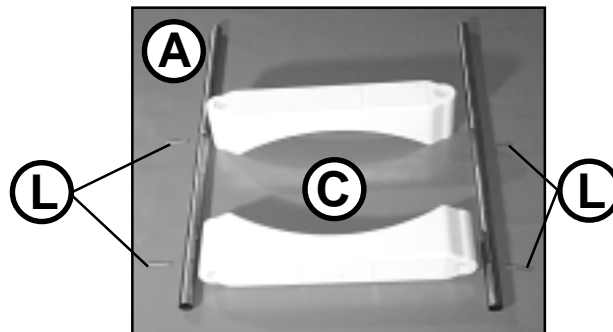

## Parts Needed:

- A. (2) Interior Step Rails
- C. (2) Interior Steps
- L. (4) Metal Pins
- M. (2) Plastic Plugs

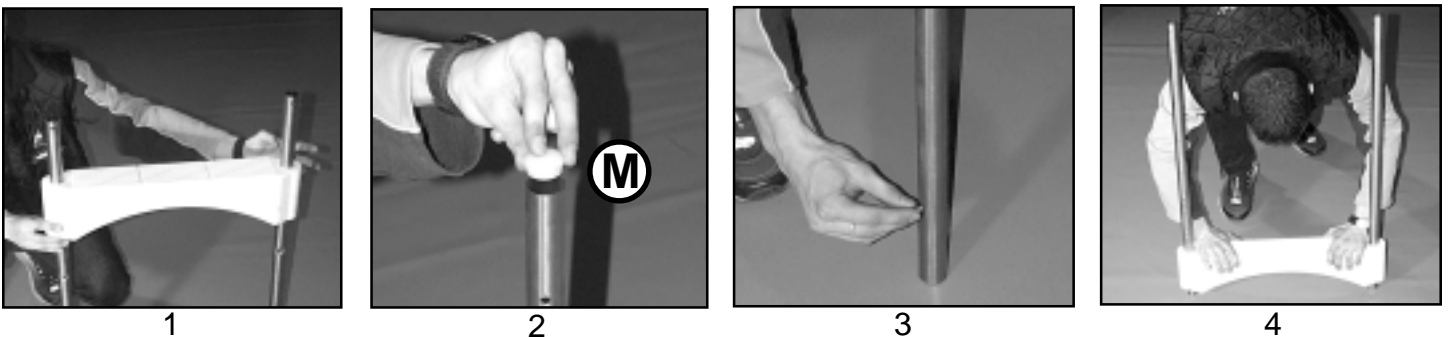

1. Apply the Plastic Plugs to the top holes of the two Interior Step Rails. 2. Begin sliding the first Interior Step towards the bottom of the Interior Step Rails. 3. Now insert two Metal Pins into the Interior Step Rail's holes. 4. Push the Interior Step into place. Use the same procedure for the remaining Interior Step.

# Step 3: Assembling the Outside Ladder Steps

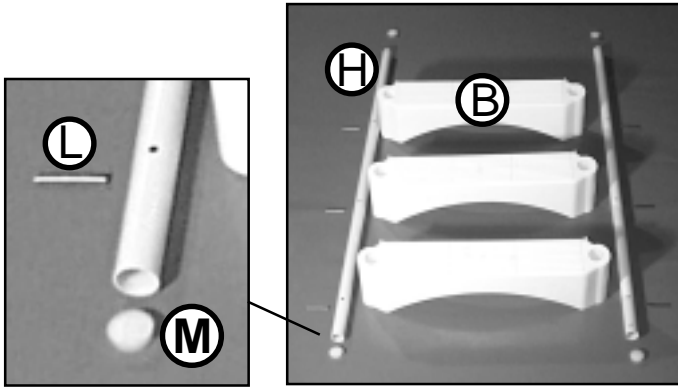

## Parts Needed:

- B. (3) Exterior Steps (Tabs)
- H. (2) Exterior Step Rails (White)
- L. (6) Metal Pins
- M. (4) Plastic Plugs

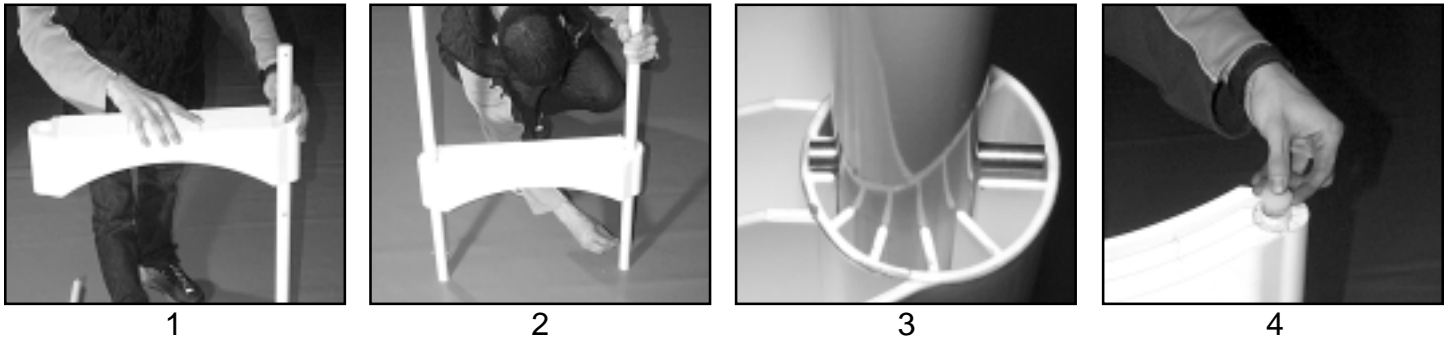

1. Slide the first Exterior Step toward the bottom of the Exterior Step Rails (white). 2. Now insert two Metal Pins into the Exterior Step Rails' holes and push the Exterior Step down into place. 3. Make sure the metal pin is locked into place. 4. Put the four Plastic Plugs into the four holes on the Exterior Step Rails.

# Step 4: Connecting the Ladder Top with the Ladder's Waterside Steps

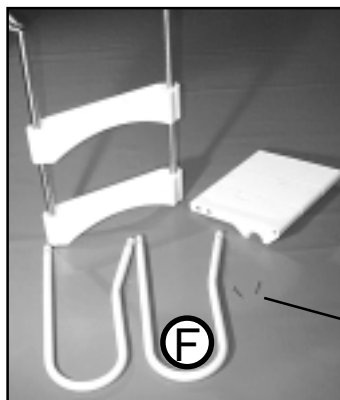

## Parts Needed:

- Assembled Platform
- Assembled Interior Steps
- F. (2) Top Ladder Handles
- N. (2) Metal Screws

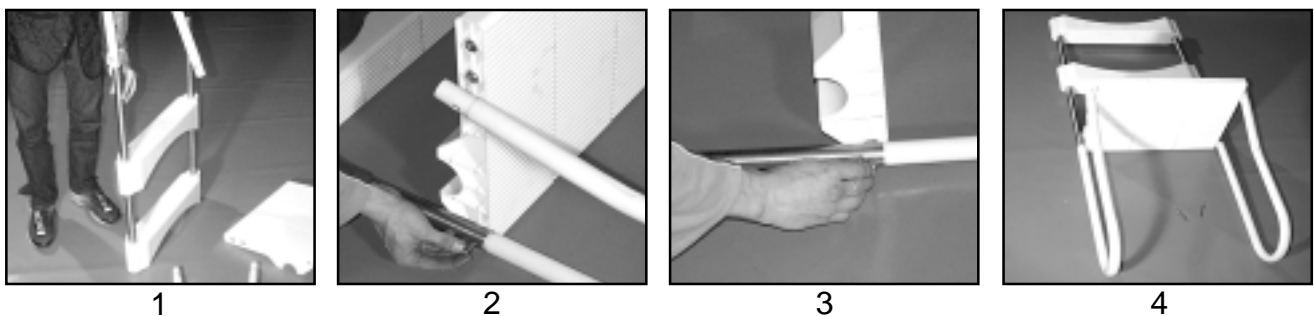
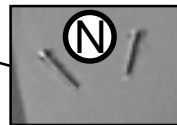

1. Insert the two Top Ladder Handles into the assembled Interior Step's holes. 2. Insert the Assembled Platform, lining up the holes for the Metal Screws. 3. Insert the Metal Screws, apply the Nuts and Washers and tighten with the Ladder Tool. 4. The Interior Steps are now complete.

## Step 5: Connecting the Assembled Ladder with the Outside Legs

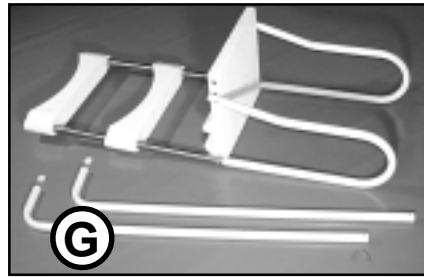
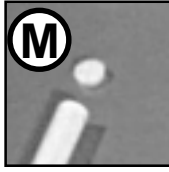
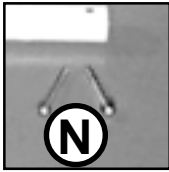

### Parts Needed:

Assembled Interior Steps  
 G. (2) Vertical Supports  
 M. (2) Plastic Plugs  
 N. (2) Metal Screws with Nuts and Washers



1



2



3

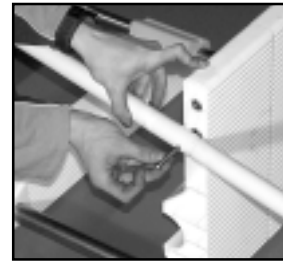

4



5

1. Put the plastic plugs into the holes on the bottom of the curved ends of the Vertical Supports. 2. Insert the two Vertical Supports into the Top Ladder Handles. (The curved Vertical Support ends should be facing the Interior Steps.) 3. Line up the holes for the Metal Screws. 4. Using the Ladder Tool, tighten the Metal Screws with the corresponding Nuts and Washers. 5. The outside Vertical Supports are now attached.

## Step 6: Connecting the Assembled Ladders

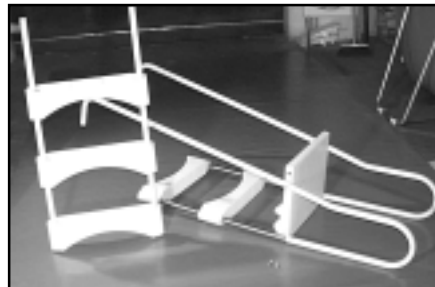

### Parts Needed:

Assembled Inside Steps  
 Assembled Outside Steps  
 N. (2) Metal Screws



1

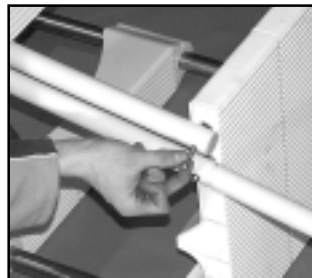

2

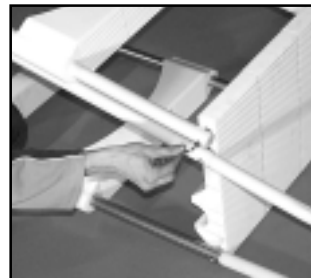

3



4

1. Place the SplashLadder's Exterior Steps on the outside of the Vertical Supports. (Be sure the Exterior Steps slope down and away from the pool.) 2. Line up the holes of the Platform piece and the Exterior Steps for the Metal Screws. 3. Using the Ladder Tool, tighten the Metal Screws with the corresponding Nuts and Washers. 4. The SplashLadder assembly is now complete.

Please note: If you have purchased an OmegaPool, please refer to the last page of the manual for the OmegaLadder "Horseshoe" Berth Pipe installation instructions.

## Step 7: Attaching the Berth Pipe to the SplashLadder

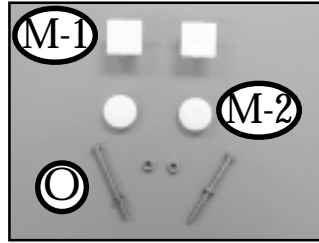
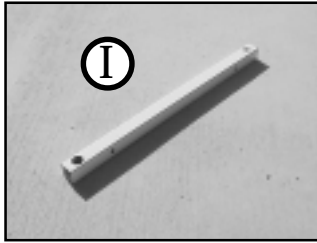

### Parts Needed:

- I. (1) Berth Pipe
- M-1. (2) Square Plastic Plugs with Nut Slot
- M-2. (2) Round Plastic Plugs
- O. (2) Long Metal Screws with Nuts and Washers



1



2



3



4



5

1. Insert Metal Nut into hex shaped recess in Square Plastic Plug (M-1), repeat with second Plug. 2. Insert Square Plastic Plug (M-1) (with nut installed) into the end of Berth Pipe, making certain to align the nut with the small hole in the Berth Pipe. Repeat at other end. 3. Line up one nut hole in Berth Pipe with hole in Bottom Ladder Support. 4. Insert a Long Metal Screw, with washer, through hole in Bottom Ladder Support and screw into Berth Pipe. Repeat at other end of Berth Pipe. Do not over tighten, leaving some slack. 5. Insert Round Plastic Caps (M-2) in ends of Bottom Ladder Support.

## Step 8: Attaching the SplashLadder with the Berth Pipe to the Buttress Leg of the Pool

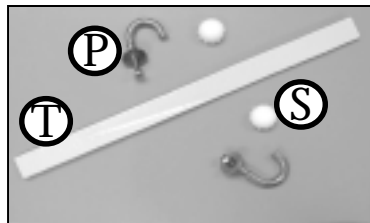

### Parts Needed:

- P. (2) Metal "J" Hooks with large Washers and Nuts
- S. (2) Round Plastic Caps
- T. (1) Long Foam Strip



1



2



3



4



5



6

1. Remove release paper from back of Long Foam Strip (T), and install Foam Strip onto the underside of the Ladder top platform. 2. Select a desired Buttress Leg on a straight side of the pool for the SplashLadder. Set Ladder onto top rail of the Splash Pool so that waterside steps are in the water and the top platform Foam Strip is resting on the top rail. 3. Attach the Berth Pipe to the Buttress Leg with the two Metal "J" Hooks (P) from inside the Buttress Leg. 4. Place the large washer on the threaded end of the "J" Hooks that extend through the Berth Pipe. 5. Tighten the "J" Hooks to the Berth Pipe with the corresponding nuts. (A wrench will be required for this step). 6. Tighten the long screws on the Berth Pipe and Bottom Ladder Supports. Screw the Round Plastic Caps (S) onto the exposed thread of the "J" Hooks. Your Splash Ladder is now secure.

## Step 9: Filling in the Details



### Parts Needed:

- K. (1) Plastic Strap (Spline)
- R. (1) Warning Label



1



2



3



4



5

1. Assemble the Safety Strap with the Plastic Spline.
2. Attach it directly below the top Exterior Step.
3. SplashLadder locked in the "open" position.
4. SplashLadder locked in the "closed" position.
5. Place the Warning Label on the outside of an Exterior Step.

***WARNING: Shallow water! Never jump or dive into any above ground pool; serious bodily injury could occur.***

***If you have any questions on the assembly of the SplashLadder, please call your local Splash dealer.***

If you have purchased an OmegaPool, these instructions replace steps(7) and (9) in your SplashLadder Instruction Manual.

# OmegaLadder Instructions



Please replace the following letters with the corresponding diagram parts list on page 1 of your SplashLadder Instruction Manual:

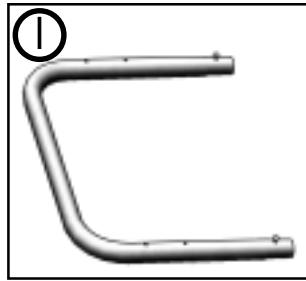

Letter (I) is now the OmegaLadder "Horseshoe" Berth Pipe

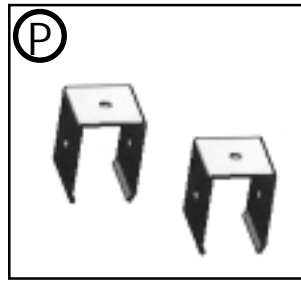

Letter (P) is now the OmegaLadder Mounting Brackets

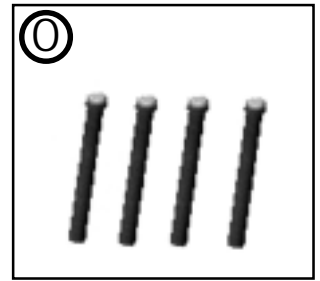

Letter (O) is now (4) Long Metal Screws w/Nuts and Washers

## Attaching the OmegaLadder Berth Pipe to the Buttress Leg

Please note: The front holes (the ones closest to the pointed ends) in the OmegaLadder Berth Pipe are for OmegaPool sizes 12' x 4' and 16' x 4'. The rear holes are for OmegaPool sizes 20' x 4' and 24' x 4'.

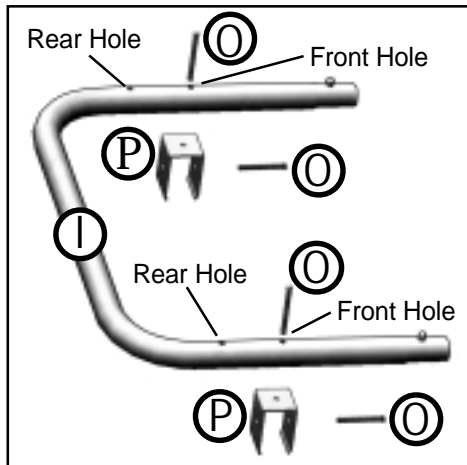

### Parts Needed:

- I. OmegaLadder "Horseshoe" Berth Pipe
- P. OmegaLadder Mounting Brackets
- O. (4) Long Metal Screws w/Nuts and Washers



1

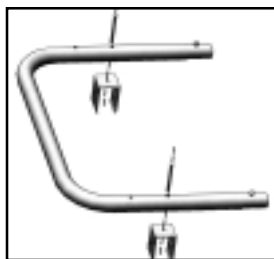

2



3



4



5

1. Select the desired OmegaPool Buttress Leg for your OmegaLadder and place the "Horseshoe" Berth Pipe on top of a OmegaPool Buttress Leg. (The pointed end should face away from the pool.) 2. Take the two Long Metal Screws and place them vertically through the OmegaLadder "Horseshoe" Berth Pipe and the OmegaLadder Mounting Brackets on the Buttress Leg. Tighten with the corresponding Nuts and Washers. 3. Take the two remaining Long Metal Screws and place them horizontally underneath the Mounting Brackets and tighten with the corresponding Nuts and Washers. 4. The OmegaLadder "Horseshoe" Berth Pipe is now secure. 5. Slide the OmegaLadder Vertical Supports into the OmegaLadder "Horseshoe" Berth Pipe until the snap couple system is in place. The OmegaLadder assembly is now complete.